



# Use of electrochemical impedance spectroscopy to assess the stability of the anion exchange membrane MA-41, modified by poly-N,N-diallylmorpholine bromide in overlimiting current modes

Denis A. Bondarev , Aslan R. Achoh , Alexander V. Bespalov, Stanislav S. Melnikov , Mikhail V. Sharafan, Viktor I. Zabolotskiy

Kuban State University, Krasnodar 350049, Russia

\* Corresponding author: [bondarev.denis1992@outlook.com](mailto:bondarev.denis1992@outlook.com)

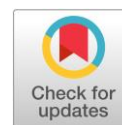

This paper belongs to a Regular Issue.

## Abstract

The paper presents the results of studying the electrochemical characteristics and long-term stability of MA-41 membranes on the surface of which poly-N,N-diallylmorpholinium bromide was applied. The deposition of a polyelectrolyte on the membrane surface leads to an increase in the limiting current from 0.8 to 1.1 mA/cm<sup>2</sup>. The comparison of the experimental and theoretically calculated values of the limiting current density allows us to conclude that the modification of the membrane surface by poly-N,N-diallylmorpholinium bromide does not lead to the formation of a continuous polyelectrolyte film on the surface, but its fixation occurs due to the sorption of macromolecules on the surface of the ion-exchanger particles. To quantify the rate of the water dissociation reaction at the membrane/solution interface, the method of electrochemical impedance was used, which makes it possible to compare the rate constants of the water dissociation reaction for different membranes, assuming that the reaction is described by the Gericher impedance. It is shown that modification of the MA-41 membrane surface leads to a decrease in the rate of the water dissociation reaction in the current range  $i = 1.5-4i_{lim}$  by a factor of 2–6. The reduction in water dissociation reaction rate is attributed to the substitution of catalytically active secondary and tertiary amino groups in the surface layer of the pristine membrane by stable heterocyclic ammonium bases of poly-N,N-diallylmorpholinium. The study of the long-term stability of the resulting membrane showed that when the membrane is polarized with a current equal to twice the limiting current, the desorption of the modifier occurs within 25 h, and the properties of the membrane become close to those of the unmodified MA-41 membrane. It was shown that the electrochemical impedance method can be used as a very sensitive method for studying the long-term stability of ion-exchange membranes.

## Keywords

electrochemical stability  
electrochemical impedance  
modification  
poly-N,N-diallylmorpholinium  
bromide

## Key findings

- The limiting current increases by 37% due to deposition of a poly-N,N-diallylmorpholinium bromide on the MA-41 membrane surface.
- A 6-fold reduction in the water dissociation reaction rate constant at the modified membrane/solution interface is achieved.
- Desorption of the polymeric modifier occurs after 25 h of operation in an over-limiting current mode ( $i = 2i_{lim}$ ).

Received: 07.08.23

Revised: 08.09.23

Accepted: 09.09.23

Available online: 13.09.23

© 2023, the Authors. This article is published in open access under the terms and conditions of the Creative Commons Attribution (CC BY) license (<http://creativecommons.org/licenses/by/4.0/>).

## 1. Introduction

Electrodialysis is an electromembrane process that removes ionic contaminants from solutions under the influence of direct electric current [1]. The transfer of ions is carried out in a membrane stack consisting of tens to hundreds of alternating cation-exchange and anion-exchange membranes. As a rule, the process of electrodialysis is carried out under conditions when the current density applied to the electrodialyzer does not exceed the limiting current density, the value of which depends on the chemical nature of the solution, its concentration, hydrodynamics in the channel of the membrane package [1], and the nature of the ion-exchange membrane [2]. In some cases, when the treated solution contains a small amount of ions, due to the conjugated effects of concentration polarization, it is more advantageous to carry out the process at a current density exceeding the limiting one [3]. This process is sometimes referred to as high-intensity electrodialysis.

An undesirable process in this case is the occurrence of the water dissociation reaction, which, as a rule, is localized at the anion-exchange membrane/solution interface [4, 5]. Under such conditions, commercial anion-exchange membranes (such as MA-41, Neosepta AMX, Ralex AMH, etc.) based on benzyltrimethylammonium undergo thermal alkaline hydrolysis of their anion-exchange functional groups [6] (Figure 1).

The water dissociation reaction rate increase is observed as in the case of a chemical degradation of the ion-exchange groups and when the anion-exchange membrane is subjected to the electrochemical degradation due to prolonged operation at overlimiting current modes ( $i > i_{lim}$ ) [4].

The transformation of quaternary ammonium bases into tertiary amines in the surface layer of the anion-exchange membrane further increases the water dissociation reaction rate [4].

It is worth noting that the MA-41 membrane contains both secondary and tertiary amines in the surface layer, ranging from 4% to 25%, which is attributed to the heating of the ion-exchange resin to 120–140 °C during the fabrication of the membrane through hot pressing [4, 7]. Consequently, even the pristine MA-41 membrane is active in the water dissociation reaction [4, 8].

Conversion of quaternary ammonium bases to amines has a negative impact on the electrodialysis process at different levels [9].

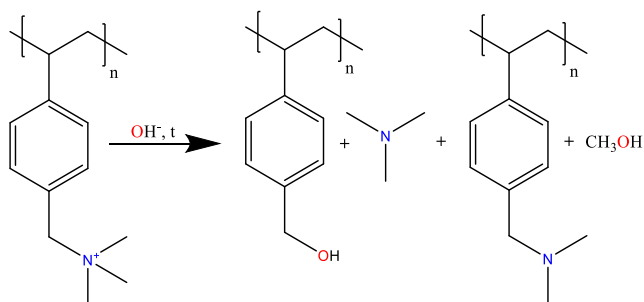
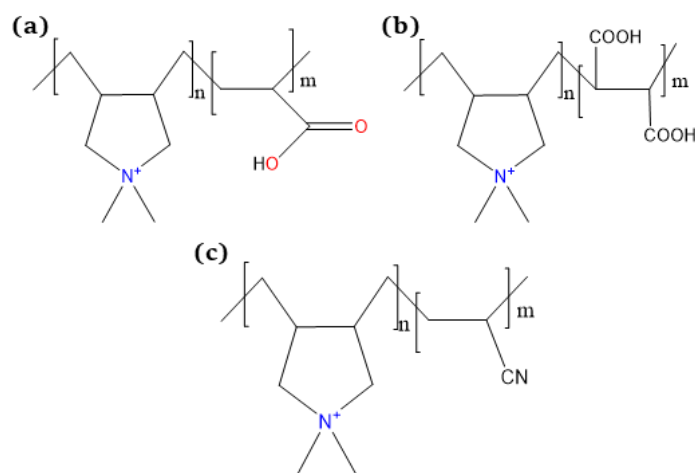

**Figure 1** Scheme for the hydrolysis of the benzyltrimethylammonium fragment of commercial anion exchange membranes, adapted from [6].

First, it results in an increase of membrane resistance. Second, and more importantly, the water dissociation reaction on the anion-exchange membrane (the reaction rate of which is increased by amines) leads to a pH value decrease in the desalting chambers and its increase in the concentration chambers of an electrodialysis module. In the case of treating solutions containing hardness salts, this raises the risk of scaling formation [10]. Additionally, the intensive water dissociation reaction reduces the space-charge density at the membrane/solution interface and suppresses the development of electroconvection [5, 11, 12]. Therefore, it is crucial to increase the electrochemical stability of ion-exchange groups in anion-exchange membranes and reduce the intensity of water dissociation at the membrane/solution interface [13].

In order to enhance the electrochemical stability of commercial anion-exchange membranes and reduce the intensity of water dissociation, polymeric modifiers utilizing various copolymers of *N,N*-diallyl-*N,N*-dimethylammonium chloride (DADMAC) were employed [4, 14, 15]. The structure of these modifiers is depicted in Figure 2. The mechanism by which these modifiers function is based on the substitution of catalytically active secondary and tertiary amines in the surface layer of the modified membrane with stable heterocyclic ammonium fragments (Figure 2). This substitution results in a reduction in the intensity of the water dissociation reaction, the promotion of electroconvection, and in an overall increase of the salt flux through the electromembrane system [4].

The pyrrolidine fragment, which is a five-membered heterocyclic ring in the polymer modifiers, exhibits considerable resistance to Hoffman elimination and various nucleophilic substitutions [16, 17]. It is expected that *N*-spirocyclic polyelectrolytes, in which the quaternary nitrogen atom belongs to both cycles, will possess even greater chemical stability compared to *N,N*-dimethylpyrrolidinium derivatives [18, 19]. High potential alkaline stability makes *N*-spirocyclic polyelectrolytes a promising tools for the modification of anion-exchange membranes.



**Figure 2** Structure of DADMAC copolymers: copolymer of DADMAC and acrylic acid (a); copolymer of DADMAC and maleic acid (b); copolymer of DADMAC and acrylonitrile (c).

In the previous study, we showed that the MA-41 membrane modified with poly-N,N-diallylmorpholinium bromide exhibits low catalytic activity in the water dissociation reaction and enhanced mass transfer of salt ions (through the electroconvective mechanism) [20]. However, the question regarding the stability of the resulting modified anion-exchange membrane remained unanswered.

The aim of this work is to investigate the electrochemical stability of the MA-41 anion-exchange membrane modified with poly-N,N-diallylmorpholinium bromide using the electrochemical impedance spectroscopy.

## 2. Experimental part

The objects of the study were heterogeneous anion-exchange membranes MA-41 (Shchekinoazot LLC, Russia), and MA-41 membranes modified with poly-N,N-diallylmorpholinium bromide. The membranes were modified in an organic medium (a mixture of N-methylpyrrolidone and concentrated formic acid in a volume ratio of 1:1) according to the methodology described in [20]. The modified membranes were designated as MA-41M.

The electrochemical stability of the MA-41 and MA-41M membranes was investigated in a four-chamber electrodiagnosis cell with Luggin capillaries and platinated platinum wires (Figure 3).

Electrochemical impedance spectra of and current-voltage characteristics were obtained using a potentiostat-galvanostat AUTOLAB 100N (Metrohm, Switzerland) with a frequency impedance measurement module FRA32M. The linear flow rate of the solutions was 0.15 cm/s (9 ml/min) in both desalting and concentration chambers. In the electrode chambers, the flow rate was set at 0.3 cm/s (18 mL/min). The experiments were performed using 0.02 M NaCl solution in the desalting and concentration chambers and 0.05 M Na<sub>2</sub>SO<sub>4</sub> solution in the electrode chambers.

The channel dimensions were 2 (length) × 2 (width) × 0.5 (intermembrane distance) cm.

The experimental limiting current value was determined using the tangent method [21]. The value of the experimental limiting current density was used as the reference for the subsequent electrochemical impedance measurements. The theoretical value of the limiting current density was calculated using the Leveque equation [22]:

$$i_{lim} = \frac{FDC^0}{h(T-t)} \left( 1.47 \frac{h^2 v}{LD} \right)^{1/3}, \quad (1)$$

where  $F$  is the Faraday constant, (A·s)/mol;  $D$  is the electrolyte diffusion coefficient, m<sup>2</sup>/s;  $C^0$  is the concentration of the electrolyte, mol/m<sup>3</sup>;  $T$  is the transport number of the counterion in the membrane and  $t$  is the transport number of the counterion in the solution;  $h$  is the distance between the membranes, m;  $L$  is the channel length, m;  $v$  is the linear velocity, m/s.

The electrochemical impedance spectra were recorded using the following procedure: direct current with a superimposed alternating signal was applied to the polarizing electrodes. Impedance measurements were conducted using platinated platinum wires. The frequencies of alternating current were 1·10<sup>6</sup>–3·10<sup>3</sup> Hz. The amplitude of the alternating current was set to 200 μA.

The investigated electromembrane system was studied under different constant polarizing currents, corresponding to underlimiting (0.9*i*<sub>lim</sub>), limiting (1.0*i*<sub>lim</sub>), and overlimiting (1.1–4.0*i*<sub>lim</sub>) modes. The time required for the system to reach a quasiequilibrium state at a given polarizing current density ranged from 1200 to 3600 s. It is important to note that at lower current densities the time to reach equilibrium was longer.

The impedance of the system was determined by calculating the difference between the complex resistances of the system measured with and without the membrane under study [23] using equation 2:

$$Z = Z_{mb+cap+sol} - Z_{cap+sol}, \quad (2)$$

where  $Z_{mb+cap+sol}$  is the total system impedance with membrane (mb), measuring electrodes (cap) and solution (sol);  $Z_{cap+sol}$  is the total system impedance without membrane.

Electrochemical impedance spectra were processed using the equivalent circuit method in the EC-Lab Demo program.

## 3. Results and Discussion

The current-voltage characteristics of MA-41 and MA-41M membranes are shown in Figure 4.

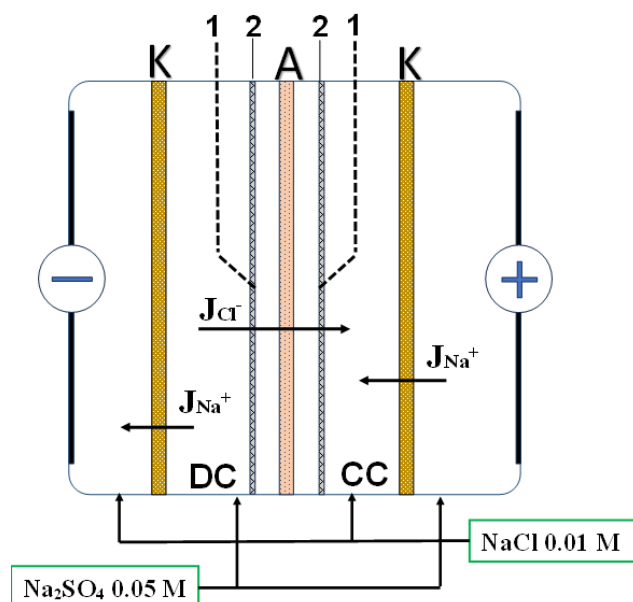

**Figure 3** Scheme of the electrochemical cell used to investigate the current-voltage characteristics and electrochemical impedance of the studied membranes: 1 – Luggin capillaries; 2 – platinum electrodes; K – auxiliary cation-exchange membranes MK-40; A – anion-exchange membrane MA-41 or MA-41M, DC – desalting channel, CC – concentrating channel.

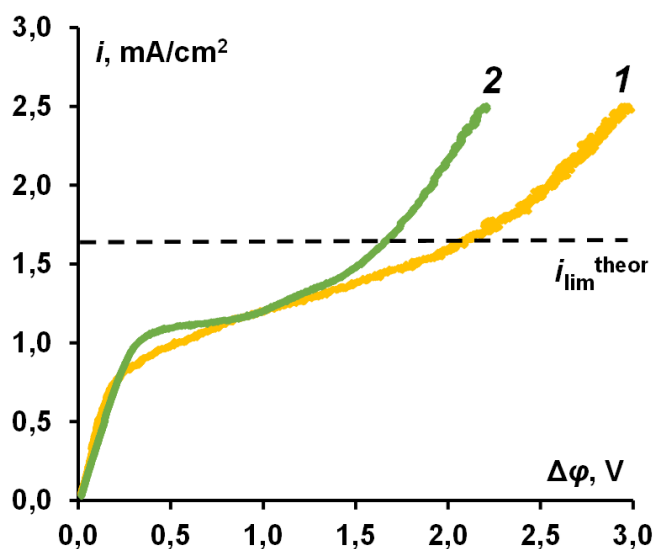

**Figure 4** General current-voltage characteristics of the membranes: 1 - MA-41; 2 - MA-41M membrane; the dashed line indicates the theoretical limiting current density, calculated according to the Leveque equation (Equation 1).

The results are in qualitative agreement with the previous study conducted using a rotating membrane disk [20]. Application of the modifier results in an increase in the limiting current density in the electromembrane system. The limiting current density for the pristine MA-41 membrane is  $0.8 \text{ mA/cm}^2$ , whereas for the MA-41M membrane it is  $1.1 \text{ mA/cm}^2$ . In both cases, the obtained values of the limiting current density are significantly lower than the calculated theoretical value,  $1.6 \text{ mA/cm}^2$ .

The significant discrepancy between the experimental and theoretical limiting current densities for the MA-41 membrane is attributed to the heterogeneity of the membrane's surface, where non-conductive areas of polyethylene reduce the active surface area [13, 24, 25]. The fact that the limiting current value for the modified membrane is also significantly lower than the theoretical value indicates that poly-N,N-diallylmorpholine does not form a continuous film on the membrane-substrate surface. Thus, the modification of the MA-41 membrane does not result in the homogenization of the membrane surface. It is possible that the modifier is fixed on the surface of the ion-exchanger particles that protrude from the modified membrane's surface.

The mechanism of MA-41 membrane modification is likely based on different degrees of membrane swelling in water and organic solvents. Previous studies showed that MA-41 and MA-40 membranes exhibit greater swelling in organic solvents like N,N-dimethylacetamide compared to that in water [26, 27]. The variation in swelling degree in heterogeneous membranes can be attributed to the increase in the linear size of the ion exchange granules, while the inert binder (polyethylene) does not interact significantly with the solvent, and its geometry remains relatively unchanged. The enlargement of the ion-exchanger granules can be explained by the specific interaction between the ion exchange resin and organic solvents such as N-methylpyr-

rolidone and formic acid. This interaction leads to an expansion of the mesopores, allowing a certain equilibrium amount of poly-N,N-diallylmorpholine to enter the ion exchange phase.

The lower swelling of the membrane in water compared to that in the organic mixture results in some of the polyelectrolyte remaining in the ion exchange resin phase after conditioning the membrane in water. This observation is supported by the IR spectroscopy data obtained from the surface of the membrane [20].

As a result, the modified membrane retains its heterogeneous nature, and the increase in the limiting current is attributed to the development of equilibrium electroconvection. This phenomenon was previously observed with polymer modifiers based on N,N-diallyl-N,N-dimethylammonium chloride [4, 14, 15].

The intensity of water dissociation reaction at the membrane/solution interface can be estimated by observing the transfer of  $\text{OH}^-$  ions through the membrane. In [20], the transport numbers of hydroxide ions through both the original and modified membranes were determined under various current modes. The results indicated that the modified membrane exhibited low catalytic activity in the water dissociation reaction.

In addition to analyzing the ions transport numbers, the changes in the electrochemical impedance spectrum of the electromembrane system can be examined to evaluate the intensity of water dissociation [28, 29]. By comparing the intensity of water dissociation at the interface of the modified membrane/solution before and after resource tests, the stability of the modified membrane can be assessed. This highlights the electrochemical impedance method as the most effective and informative approach for evaluating the quality and properties of membranes.

Different parts of the electrochemical impedance spectrum correspond to different physical and chemical processes occurring in the electromembrane system when it is exposed to a weak alternating current.

At current densities below the limiting current, several semicircles in different frequency ranges are observed in the electrochemical impedance spectrum (Figure 5, curve 1). At high-frequencies (1 MHz – 5 kHz) the impedance of the membrane and adjacent diffusion layers unfolds [30], including ohmic part of the total resistance, the charging double electrical layers and the geometric capacitance of the cell. In the low-frequency region of the spectrum (below 1 Hz), the Warburg impedance begins to unfold for a diffusion layer of finite length. The Warburg impedance is due to the change in electrolyte concentration in an electrically neutral solution under the action of varying current and potential difference. The change in concentration is slower than the change in current, resulting in a delayed change in the potential drop [23, 31]. For this reason, this impedance unfolds in the low-frequency region.

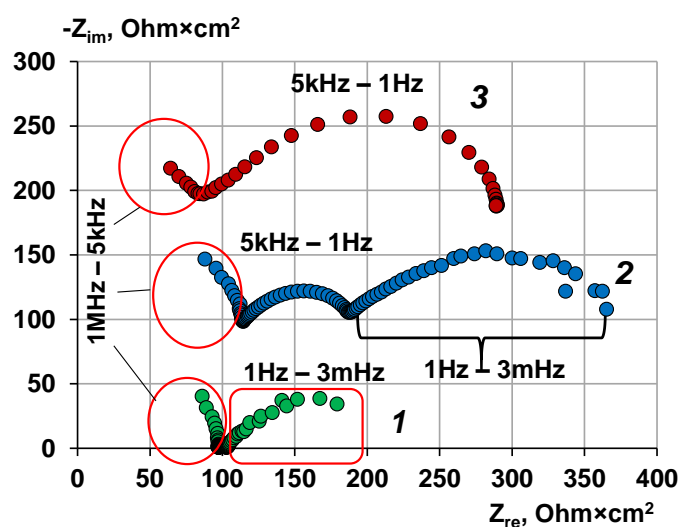

**Figure 5** The spectra of the electrochemical impedance of the MA-41M membrane are presented in Nyquist coordinates at different polarizing current densities: 1 - low current mode ( $i = 0.9i_{lim}$ ); 2 - limit current mode ( $i = 1.0i_{lim}$ ); 3 - high current mode ( $i = 4.0i_{lim}$ ), the numbers indicate the frequency ranges.

In the case of the limiting current density (Figure 5, curve 2) a new semicircle appears in the mid-frequency region (5 kHz – 1 Hz). The emergence of processes in this frequency range for systems with ion-exchange membranes is attributed to the process of the water dissociation reaction with the participation of ionogenic groups of the membrane [32] that is described by the Gerischer impedance. The nature of the Gerischer impedance is similar to the Warburg impedance. An increase in the current density leads to a decrease in the concentration of all ions present at the membrane/solution boundary, which also leads to an increase in the potential drop. However, the concentration recovery in the boundary layer is not only due to diffusion but also due to the chemical reaction. Since the chemical reaction proceeds at a high rate, the characteristic frequencies of the Gerischer impedance are higher than those of the Warburg impedance [29].

When the electromembrane system is in an over-limiting current mode, the Warburg impedance disappears in the low-frequency region (below 1 Hz), and the complete dominance of the Gerischer impedance is observed (Figure 5, curve 3).

In electromembrane systems, the Gerischer impedance is used to estimate the intensity of water dissociation [28, 33]. The Gerischer impedance can be written in the following form:

$$Z_G = \frac{R_G}{\sqrt{\chi + j\omega}} \quad (3)$$

where  $R_G$  is the resistance of the active component of the Gerischer impedance  $\text{Ohm}\cdot\text{cm}^2$ ;  $\chi$  is the water dissociation reaction rate constant,  $\text{s}^{-1}$ ;  $\omega$  is the cyclic frequency,  $\text{rad/s}$ ;  $j$  is the imaginary unit.

In the case of an anion-exchange membrane, the Gerischer impedance resistance ( $R_G$ ) is described by the

following equation [28]:

$$R_G = \frac{RT\bar{t}_{OH}}{F^2(C_{OH^-})_{x=0}\sqrt{D_{H^+}\chi}} \quad (4)$$

where  $R$  is the universal gas constant,  $\text{J}/(\text{mol}\cdot\text{K})$ ;  $T$  is the absolute temperature,  $\text{K}$ ;  $\bar{t}_{OH}$  is the transport number of hydroxides in the membrane;  $(C_{OH^-})_{x=0}$  is the concentration of hydroxide ions at the interface,  $\text{mol}/\text{m}^3$ ;  $D_{H^+}$  is the diffusion coefficient of hydrogen ion in solution,  $\text{m}^2/\text{s}$ .

The value of the water dissociation reaction rate constant [28],  $\chi$ , makes a significant contribution to the reaction resistance and is described by equation 5:

$$\chi = \frac{2\pi f_{Gmax}}{\sqrt{3}} \quad (5)$$

where  $f_{Gmax}$  is the frequency (in Hz) at the point corresponding to the maximum value of the imaginary resistance component on the Gerischer impedance arc.

The contribution of the transport number of hydroxide ions in the membrane as well as their concentration and the water dissociation reaction rate constant can influence the behavior of the electromembrane system. It is possible for the system to exhibit low resistance under the Gerischer impedance arc while simultaneously demonstrating a low intensity of the water dissociation reaction. Conversely, the system can also exhibit low resistance and high intensity of the water dissociation reaction.

Furthermore, an increase in the intensity of the water dissociation reaction will not only affect the resistance but also cause a frequency shift of the maximum point toward a higher frequency region. This observation can be verified by analyzing the frequency spectra of the system [28, 29].

In order to accurately determine the frequency of the maximum point, the experimental impedance spectra were analyzed using the equivalent circuit (Figure 6). The equivalent circuit fits well with experimental electrochemical impedance spectra across most of the frequency range. Figure 7 displays the analyzed electrochemical impedance spectra of the modified MA-41M membrane at both the limiting and over-limiting electric current densities.

The values of the water dissociation reaction rate constant are shown in Figure 8. From Figure 8, it is evident that with an increase in current density ( $i_{lim} \rightarrow 4i_{lim}$ ) there is an increase in the water dissociation reaction rate constant for all studied membranes.

The intensity of the water dissociation reaction is influenced not only by the catalytic activity of functional groups but also by the strength of the electric field.

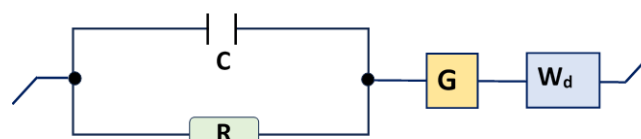

**Figure 6** Equivalent circuit for processing spectra of electrochemical impedance: C - capacitance element; R - element of resistance; G - Gerischer element;  $W_d$  - Warburg element.

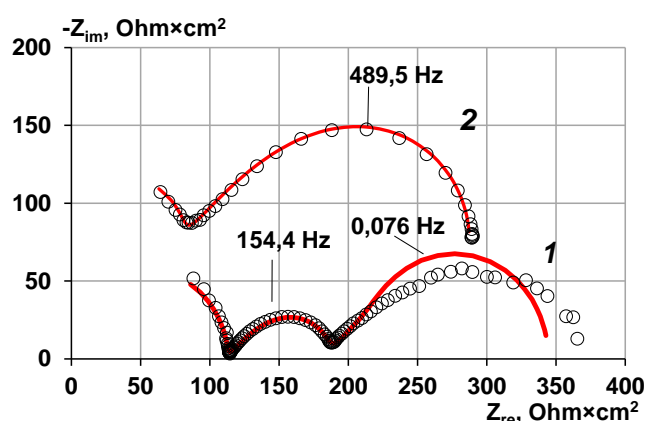

**Figure 7** Processed spectra of the electrochemical impedance of the MA-41M membrane presented in Nyquist coordinates: 1 -  $i_{lim}$ ; 2 -  $4i_{lim}$ ; marker - experimental data; solid line - the processed spectrum by the method of equivalent circuits; the numbers in the figures show the maximum points for the Warburg and Gerischer impedance semicircle.

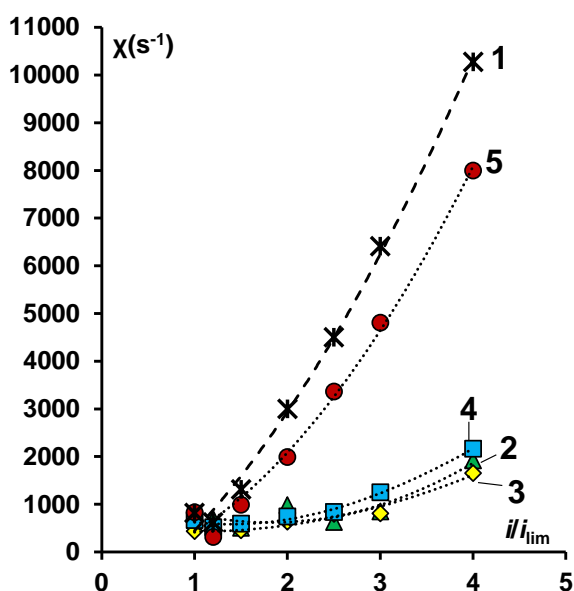

**Figure 8** Dependence of water dissociation reaction rate constant on dimensionless current density and time of resource tests: 1 - original MA-41 membrane; 2 - modified MA-41M membrane; 3 - MA-41M after 10 h of testing; 4 - MA-41M after 25 h of testing; 5 - MA-41 after 50 h of testing.

The later is determined by the potential difference across the membrane/solution interface and exponentially increases with an increase in the polarizing current density [34]. As a consequence, the water dissociation reaction rate constant increases, leading to an increase in the intensity of the water dissociation reaction at the membrane/solution interface for both the MA-41 and MA-41M membranes.

However, on the pristine MA-41 membrane, water dissociation occurs more intensely, as indicated by the steeper dependence of the water dissociation reaction rate constant on the dimensionless current density (Figure 8, curves 1 and 2). The water dissociation reaction rate constant on the modified membrane at  $i = 4i_{lim}$  is  $1650 \text{ s}^{-1}$ , while on the MA-41 membrane under the same conditions it is  $10275 \text{ s}^{-1}$ . The higher intensity of the water dissociation reaction on the

initial membrane can be attributed to the presence of catalytically active secondary and tertiary amino groups in the surface layer of the anion-exchange membrane [7].

The data shown in Figure 8 confirms the low intensity of the water dissociation reaction at the MA-41M/solution interface, which persists during the initial 25 h of the resource tests. However, it was observed that after 50 h of high-intensity electro dialysis, the intensity of the water dissociation reaction at the MA-41M/solution interface increases almost to the level exhibited by the pristine MA-41 membrane.

The deterioration of electrochemical characteristics of the modified membrane can occur due to the following processes: 1) the destruction of quaternary ammonium groups of the polymer modifier (poly-N,N-diallylmorpholine), leading to the formation of secondary and tertiary amines that accelerate the water dissociation process; 2) the desorption of poly-N,N-diallylmorpholine from the surface of the modified membrane, resulting in the restoration of the surface layer to its initial state.

Figure 9 shows the electrochemical impedance spectra of the MA-41 and MA-41M membranes as a function of the time of resource tests (0.25 and 50 h at  $i = 2i_{lim}$ ). As can be seen from Figure 9a and b, with increasing polarizing current density, a change in the shape of the electrochemical impedance spectra is observed for both the original and the modified membrane. With increasing current density, upon the transition from  $1.5i_{lim}$  to  $4i_{lim}$ , there is a decrease in the active resistance of the Gerischer impedance as well as a decrease in the ohmic resistance of the membrane and adjacent diffusion layers due to the transition of the membrane into a more conductive  $\text{OH}^-$ -form.

To confirm the degradation of the MA-41M membrane after the resource tests, an infrared (IR) spectrum was recorded from its surface (Figure 10). The obtained IR spectroscopy data reveal the absence of stretching and bending vibration bands of poly-N,N-diallylmorpholine (in the range of  $3700\text{--}3000 \text{ cm}^{-1}$  and  $1800\text{--}600 \text{ cm}^{-1}$ ) in the spectrum of the MA-41M membrane. However, the spectrum of the modified membrane closely resembles that of the original MA-41 membrane, where the dominant bands correspond to polyethylene (in the ranges of  $3000\text{--}2800 \text{ cm}^{-1}$ ,  $1500\text{--}1400 \text{ cm}^{-1}$ , and  $800\text{--}600 \text{ cm}^{-1}$ ). Furthermore, the spectrum of the MA-41M membrane after the resource tests does not exhibit vibrations characteristic of tertiary amines and multiple bonds, which could be present due to alkaline degradation of poly-N,N-diallylmorpholine (Figure 11).

These findings, in conjunction with the electrochemical characteristics of the modified membrane after the resource tests, suggest the involvement of polyelectrolyte desorption from the surface and volume of the membrane. Additionally, poly-N,N-diallylmorpholinium itself is known to be a relatively stable polyelectrolyte in alkaline solutions [18] and is only degraded in concentrated alkaline solutions (1 M KOH) at high temperatures ( $120 \text{ }^\circ\text{C}$ ), which were not present during the resource tests.

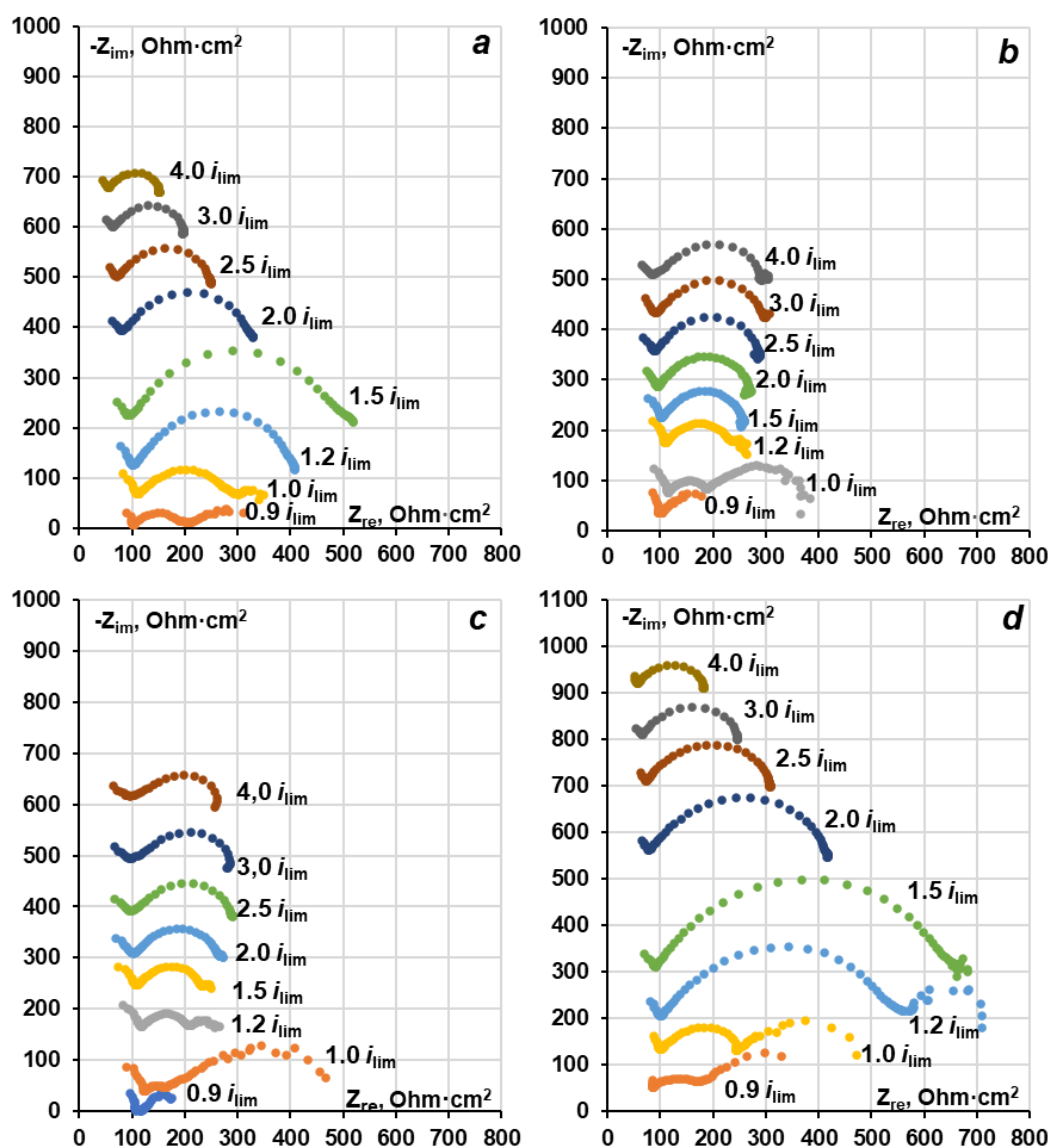

**Figure 9** The electrochemical impedance spectra are presented in Nyquist coordinates: initial MA-41 membrane (a); MA-41M membrane before durability tests (b); MA-41M membrane after 25 h of durability tests (c); MA-41M membrane after 50 h of durability tests (d); the numbers next to the spectra correspond to exceed the limit density of the electric current.

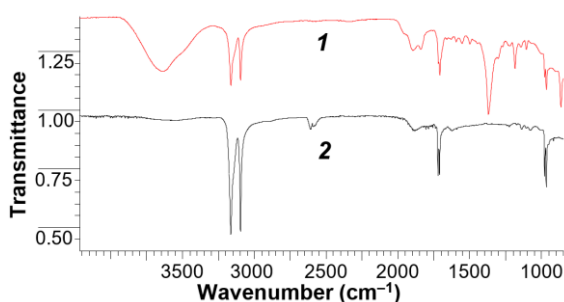

**Figure 10** IR spectra of the MA-41M membrane surface: 1 – before resource tests; 2 – after 50 h of resource tests.

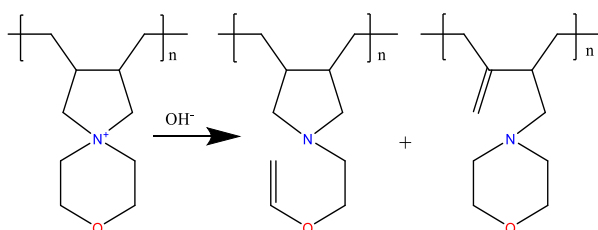

**Figure 11** Destruction of the poly-N,N-diallylmorpholinium cation during Hoffmann elimination.

## 4. Limitations

The assessment of stability in anion-exchange membranes faces the challenge of selecting a technique that can effectively monitor the degradation of modified membranes under the influence of electric current. The analysis of electrochemical impedance spectra allows for the decomposition of the processes occurring in the electromembrane system at specific electric current densities. However, data analysis typically occurs after irreversible changes have taken place in the membrane system, making it difficult to identify the causes of membrane degradation.

When analyzing electrochemical impedance spectra, it is essential to consider the time constants of Gerischer and Warburg impedance, which are obtained through spectral processing. There are cases where the experimental and theoretical spectra align well, suggesting a Gerischer impedance time constant of  $10^2$ – $10^3$  s. However, in reality, the time constant of the Gerischer impedance should fall within

the range of  $10^{-2}$  to  $10^{-6}$  s. In such instances, the time constant of the Warburg impedance may become unrealistically low. To ensure accurate spectrum processing, manual adjustment of the appropriate range of constants for both the Gerischer impedance and the Warburg impedance is necessary.

Another research challenge lies in the inability to visualize the processes occurring on the surface of ion-exchange membranes during the flow of electric current, hampering the monitoring of modifier desorption from the membrane surface. To validate these processes, various comprehensive research methods, such as scanning electron microscopy, are required. However, it is important to note that these methods can introduce mechanical and chemical influences that may distort the true characteristics of the membrane.

Furthermore, in addition to the aforementioned challenges, the issues in obtaining stable modified membranes remain unresolved.

## 5. Conclusions

Electrochemical characteristics and stability of the MA-41 membrane modified with poly-N,N-diallylmorpholinium bromide was studied. The water dissociation reaction rate constant found from the electrochemical impedance spectra of the modified MA-41M membrane is 6 times lower than that for the pristine MA-41 membrane due to screening of the secondary and tertiary amino groups of the ion-exchange resin of the MA-41 membrane with poly-N,N-diallylmorpholinium heterocyclic ammonium bases. The stability of the modified membrane is maintained for 25 h of operation at a twofold excess of the limiting current density. Subsequent operation of the membrane leads to the desorption of the polyelectrolyte from the membrane surface, which is confirmed by IR spectroscopy. As a result, after 50 h of operation the water dissociation reaction rate constant of the modified membrane rises from 1650 to 8000  $\text{s}^{-1}$ , while for the pristine MA-41 membrane the value of the constant is close to 10000  $\text{s}^{-1}$ .

## • Supplementary materials

No supplementary materials are available.

## • Funding

This research was funded by the Ministry of Science and Higher Education of the Russian Federation, project number FZEN-2023-0006.

## • Acknowledgments

None.

## • Author contributions

Conceptualization: D.A.B., V.I.Z.  
 Data curation: D.A.B., S.S.M., A.R.A.  
 Formal Analysis: D.A.B., S.S.M., A.R.A.  
 Funding acquisition: M.V.S.  
 Investigation: D.A.B.  
 Methodology: D.A.B., A.V.B.  
 Project administration: M.V.S.  
 Resources: D.A.B., A.V.B.  
 Software: S.S.M.  
 Supervision: M.V.S., V.I.Z.  
 Validation: S.S.M., D.A.B.  
 Visualization: D.A.B., S.S.M., A.R.A.  
 Writing – original draft: D.A.B.  
 Writing – review & editing: D.A.B., S.S.M., A.R.A.

## • Conflict of interest

The authors declare no conflict of interest.

## • Additional information

Author IDs:

Denis A. Bondarev, Scopus ID [57204157762](https://orcid.org/57204157762);  
 Stanislav S. Melnikov, Scopus ID [41561671700](https://orcid.org/41561671700);  
 Aslan R. Achoh, Scopus ID [57195274953](https://orcid.org/57195274953);  
 Alexander V. Bepalov, Scopus ID [56803505300](https://orcid.org/56803505300);  
 Mikhail V. Sharafan, Scopus ID [9237231200](https://orcid.org/9237231200);  
 Viktor I. Zabolotskiy Scopus ID [57307216300](https://orcid.org/57307216300).

Website:

Kuban State University, <https://kubsu.ru/>.

## References

1. Strathmann H. Electrodialysis, a mature technology with a multitude of new applications. *Desalination*. 2010;264:268–288. doi:[10.1016/j.desal.2010.04.069](https://doi.org/10.1016/j.desal.2010.04.069)
2. Urtenov MK, Uzdenova AM, Kovalenko AV, Nikonenko VV, Pismenskaya ND, Vasil'eva VI, Sistas P, Pourcelly G. Basic mathematical model of overlimiting transfer enhanced by electroconvection in flow-through electrodialysis membrane cells. *J Membr Sci*. 2013;447:190–202. doi:[10.1016/j.memsci.2013.07.033](https://doi.org/10.1016/j.memsci.2013.07.033)
3. Nikonenko VV, Kovalenko AV, Urtenov MK, Pismenskaya ND, Han J, Sistas P, Pourcelly G. Desalination at overlimiting currents: State-of-the-art and perspectives. *Desalination*. 2014;342:85–106. doi:[10.1016/j.desal.2014.01.008](https://doi.org/10.1016/j.desal.2014.01.008)
4. Zabolotskiy VI, But AY, Vasil'eva VI, Akberova EM, Melnikov SS. Ion transport and electrochemical stability of strongly basic anion-exchange membranes under high current electrodialysis conditions. *J Membr Sci*. 2017;526:60–72. doi:[10.1016/j.memsci.2016.12.028](https://doi.org/10.1016/j.memsci.2016.12.028)
5. Nikonenko VV, Mareev SA, Pis'menskaya ND, Uzdenova AM, Kovalenko AV, Urtenov MK, Pourcelly G. Effect of electroconvection and its use in intensifying the mass transfer in electrodialysis. *Russ J Electrochem*. 2017;53:1122–1144. doi:[10.1134/S1023193517090099](https://doi.org/10.1134/S1023193517090099)



6. Bauer B, Strathmann H, Effenberger F. Anion-exchange membranes with improved alkaline stability. *Desalination*. 1990;79:125-144. doi:[10.1016/0011-9164\(90\)85002-R](https://doi.org/10.1016/0011-9164(90)85002-R)
7. Akberova EM, Malyhin MD. Strukturnye i fiziko-himicheskie karakteristiki anionoobmennyykh membran MA-40 i MA-41 posle termohimicheskogo vozdejstviya [Structural and physico-chemical characteristics of anion-exchange membranes MA-40 and MA-41 after thermochemical exposure. Sorption and chromatographic processes]. *Sorbcionnye i hromatograficheskie processy*. 2014;14(2):232-239. Russian.
8. Shaposhnik VA, Kastyuchik AS, Kozaderova OA. Irreversible dissociation of water molecules on the ion-exchange membrane-electrolyte solution interface in electro dialysis. *Russ J Electrochem*. 2008;44:1073-1077. doi:[10.1134/S1023193508090139](https://doi.org/10.1134/S1023193508090139)
9. Loza SA, Smyshlyaev NA, Korzhov AN, Romanyuk NA. Electro dialysis concentration of sulfuric acid. *Chim Techno Acta*. 2021;8(1):20218106. doi:[10.15826/chimtech.2021.8.1.06](https://doi.org/10.15826/chimtech.2021.8.1.06)
10. Andreeva MA, Gil VV, Pismenskaya ND, Nikonenko VV, Dammak L, Larchet C, Grande D, Kononenko NA. Effect of homogenization and hydrophobization of a cation-exchange membrane surface on its scaling in the presence of calcium and magnesium chlorides during electro dialysis. *J Membr Sci*. 2017;540:183-191. doi:[10.1016/j.memsci.2017.06.030](https://doi.org/10.1016/j.memsci.2017.06.030)
11. Pismenskaya ND, Belova EI, Nikonenko VV, Zabolotsky VI, Lopatkova GY, Karzhavin Y N, Larchet C. Lower rate of H<sup>+</sup>(OH<sup>-</sup>) ions generation at an anion-exchange membrane in electro dialysis. *Desalination Water Treat*. 2010;21:109-114. doi:[10.5004/dwt.2010.1268](https://doi.org/10.5004/dwt.2010.1268)
12. Slouka Z, Senapati S, Yan Y, Chang HC. Charge inversion, water splitting, and vortex suppression due to DNA sorption on ion-selective membranes and their ion-current signatures. *Langmuir*. 2013;29:8275-8283. doi:[10.1021/la4007179](https://doi.org/10.1021/la4007179)
13. Bondarev D, Melnikov S, Zabolotskiy V. New homogeneous and bilayer anion-exchange membranes based on N, N-diallyl-N, N-dimethylammonium chloride and ethyl methacrylate copolymer. *J Membr Sci*. 2023;675:121510. doi:[10.1016/j.memsci.2023.121510](https://doi.org/10.1016/j.memsci.2023.121510)
14. Knyaginicheva EV, Belashova ED, Pismenskaya ND. Elektrohimicheskie karakteristiki membrany AMH, modifitsirovannoy sil'nymi bifunktsional'nymi polielektrolitami. [Electrochemical characteristics of the AMX membrane modified with strong bifunctional polyelectrolytes.] *Sorbcionnye i hromatograficheskie processy*. 2014;14(5):864-868. Russian.
15. Butylskii DY, Troitskiy VA, Sharafan MV, Pismenskaya ND, Nikonenko VV. Scaling-resistant anion-exchange membrane prepared by in situ modification with a bifunctional polymer containing quaternary amino groups. *Desalination*. 2022;537:115821. doi:[10.1016/j.desal.2022.115821](https://doi.org/10.1016/j.desal.2022.115821)
16. Marino MG, Kreuer KD. Alkaline stability of quaternary ammonium cations for alkaline fuel cell membranes and ionic liquids. *ChemSusChem*. 2015;8:513-523. doi:[10.1002/cssc.201403022](https://doi.org/10.1002/cssc.201403022)
17. Cotanda P, Petzetakis N, Jiang X, Stone G, Balsara NP. Hydroxide-ion transport and stability of diblock copolymers with a polydiallyldimethyl ammonium hydroxide block. *J Polym Sci Part A Polym Chem*. 2017;55(13):2243-2248. doi:[10.1002/pola.28611](https://doi.org/10.1002/pola.28611)
18. Olsson JS, Pham TH, Jannasch P. Poly (N,N-diallylazacycloalkane)s for anion-exchange membranes functionalized with N-spirocyclic quaternary ammoniumcation. *Macromolec*. 2017;50:2784-2793. doi:[10.1021/acs.macromol.7b00168](https://doi.org/10.1021/acs.macromol.7b00168)
19. Pham TH, Olsson JS, Jannasch P. Poly (arylene alkylene)s with pendant N-spirocyclic quaternary ammonium cations for anion exchange membranes. *J Mater Chem A*. 2018;6:16537-16547. doi:[10.1039/C8TA04699A](https://doi.org/10.1039/C8TA04699A)
20. Zabolotskii VI, Bondarev DA, Bepalov AV. Electrochemical and mass transport characteristics of the strongly basic MA-41 membrane modified by poly-N,N-diallylmorpholinium. *Russ J Electrochem*. 2018;54:963-969. doi:[10.1134/S1023193518130529](https://doi.org/10.1134/S1023193518130529)
21. Krol JJ, Wessling M, Strathmann H. Concentration polarization with monopolar ion exchange membranes: current-voltage curves and water dissociation. *J Membr Sci*. 1999;162:145-154. doi:[10.1016/S0376-7388\(99\)00133-7](https://doi.org/10.1016/S0376-7388(99)00133-7)
22. Nikonenko SV, Urtenov MK, Kovalenko AV, Semenchin EA, Nikonenko VV. Meaning of the diffusion coefficient in Peers equation for calculating limiting current density. Numerical analysis results. *Condensed Matter and Interphases*. 2011;13(3):320-326. [Internet] <https://journal.vsu.ru/kcmf/article/view/1059> Accessed on 24 July 2023.
23. Sistas P, Kozmai A, Pismenskaya N, Larchet C, Pourcelly G, Nikonenko V. Low-frequency impedance of an ion-exchange membrane system. *Electrochim Acta*. 2008;53(22):6380-6390. doi:[10.1016/j.electacta.2008.04.041](https://doi.org/10.1016/j.electacta.2008.04.041)
24. Zabolotsky VI, Novak L, Kovalenko AV, Nikonenko VV, Urtenov MH, Lebedev KA, But AY. Electroconvection in systems with heterogeneous ion-exchange membranes. *Petrol Chem*. 2017;57:779-789. doi:[10.1134/S0965544117090109](https://doi.org/10.1134/S0965544117090109)
25. Pismenskaya ND, Pokhidnia EV, Pourcelly G, Nikonenko VV. Can the electrochemical performance of heterogeneous ion-exchange membranes be better than that of homogeneous membranes? *J Membr Sci*. 2018;566:54-68. doi:[10.1016/j.memsci.2018.08.055](https://doi.org/10.1016/j.memsci.2018.08.055)
26. Gelferix F. Ionity Osnovy ionnogo obmena [Ionites. Basics of ion exchange]. Moscow: Izdat. Inostran. Lit; 1962. 491 p. Russian.
27. Demina OA, Demin AV, Gnusin NP, Zabolotskii VI. Effect of an aprotic solvent on the properties and structure of ion-exchange membranes. *Polymer Sci Ser A*. 2010;52(12):1270-1282. doi:[10.1134/S0965545X10120059](https://doi.org/10.1134/S0965545X10120059)
28. Kniaginicheva E, Pismenskaya N, Melnikov S, Belashova E, Sistas P, Cretin M, Nikonenko V. Water splitting at an anion-exchange membrane as studied by impedance spectroscopy. *J Membr Sci*. 2015;496:78-83. doi:[10.1016/j.memsci.2015.07.050](https://doi.org/10.1016/j.memsci.2015.07.050)
29. Pismenskaya ND, Rybalkina OA, Kozmai AE, Tsygurina KA, Melnikova ED, Nikonenko VV. Generation of H<sup>+</sup> and OH<sup>-</sup> ions in anion-exchange membrane/ampholyte-containing solution systems: A study using electrochemical impedance spectroscopy. *J Membr Sci*. 2020;601:117920. doi:[10.1016/j.memsci.2020.117920](https://doi.org/10.1016/j.memsci.2020.117920)
30. Barsoukov E, Macdonald JR. Impedance spectroscopy: theory, experiment, and applications, second ed., New Jersey: John Wiley & Sons; 2005. 560 p.
31. Barbero G. Warburg's impedance revisited. *Phys. Chem. Chem. Phys*. 2016;18:29537-29542. doi:[10.1039/C6CP05049B](https://doi.org/10.1039/C6CP05049B)
32. Zabolockij VI, Shel'deshov NV, Gnusin NP. Dissociatsiya molekul vody v sistemah s ionoobmennymi membranami [Dissociation of water molecules in systems with ion-exchange membranes.]. *Uspekhi himii*. 1988;57(8):1403-1414. Russian. doi:[10.1070/RC1988v057n08ABEH003389](https://doi.org/10.1070/RC1988v057n08ABEH003389)
33. Hurwitz HD, Dibiani R. Experimental and theoretical investigations of steady and transient states in systems of ion exchange bipolar membranes. *J Membr Sci*. 2004;228:17-43. doi:[10.1016/j.memsci.2003.09.009](https://doi.org/10.1016/j.memsci.2003.09.009)
34. Umnov VV, Shel'deshov NV, Zabolotskii VI. Current-voltage curve for the space charge region of a bipolar membrane. *Russ J Electrochem*. 1999;35:871-878.